

2013 **MUSTANG SHELBY GT 500** Supplement

fordowner.com
ford.ca



Table of Contents

Introduction	3
Welcome	3
Shelby® GT500® Unique Features	5
Safety Belts	10
Driving your Shelby® GT500®	11
Breaking-in your vehicle	11
Transmission operation	11
Clutch protection	12
Virtual gauges	15
Track Apps	15
AdvanceTrac®	16
Brakes	20
Launch control	20
Electronically selectable dampers	21
Engine over-rev	22
Ground clearance	23
Driving through water	24
Washing your vehicle	24
Wheels and Tires	25
Wheels	25
Wheel lug nut torque	25
Tire information	26
Roadside Emergencies	29
Wrecker towing	29
Maintenance	34
Engine oil	35
Air filter(s)	40

Table of Contents

Capacities and Specifications	41
Part numbers	41
Refill capacities	42
Warranty Coverage	45
Scheduled Maintenance Guide	46
Normal scheduled maintenance and log	51
Index	62

The information contained in this publication was correct at the time of going to print. In the interest of continuous development, we reserve the right to change specifications, design or equipment at any time without notice or obligation. No part of this publication may be reproduced, transmitted, stored in a retrieval system or translated into any language in any form by any means without our written permission. Errors and omissions excepted.

© Ford Motor Company 2012

Introduction

WELCOME

Congratulations on your decision to purchase or lease the latest from Ford SVT — the Shelby GT500. If you've owned or leased an SVT product in the past, we're glad you're back. If this is your first SVT vehicle, welcome to the SVT family! We are confident that our dedication to performance, quality, craftsmanship and customer service will provide many miles of exhilarating, safe and comfortable driving in your new Shelby GT500.

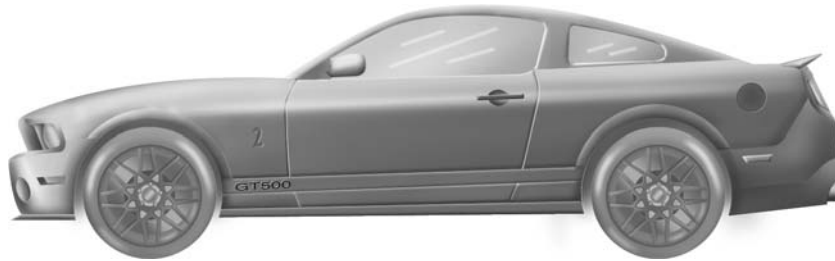

Your choice of an SVT product is an intelligent and informed one. SVT strives to build engaging vehicles that involve the driver in every aspect of the driving experience. Although performance is at the heart of every SVT vehicle, we go much further. Our goal is to deliver a comprehensive, complete vehicle, sweating the details such as the sound of the exhaust, the quality of the interior materials, and the functionality and the comfort of the seats, to make sure that the driver enjoys not only exceptional performance, but an outstanding driving environment as well. In the Shelby GT500, that philosophy is expressed by a sophisticated powertrain, outstanding chassis dynamics and significant interior and exterior enhancements.

This supplement complements your *Mustang Owner's Manual* and provides information specific to SVT and the GT500. By referring to the pages listed in this supplement, you can identify those features, recommendations and specifications unique to your new SVT vehicle. If there are any discrepancies between this supplement and the Mustang Owner's Manual, this supplement shall supersede the information found in the Mustang Owner's Manual.

If you have any questions or concerns regarding your Shelby GT500, please call the Ford Performance Info Center at 1-800-FORD-SVT (367-3788).

Introduction

SVT HISTORY

The Ford Special Vehicle Team (SVT) was established in 1991 to Polish the Ford Oval by creating low-volume, factory-produced vehicles designed for those select few whose idea of driving is a high-powered, passionate experience – not just a means of getting from point A to point B.

In a move to support this spirited enthusiasm, Ford Motor Company carefully integrated the wide array of talent in the company into a small, cross-functional group of engineers and product planners, housed together under one roof with a common mission: to create vehicles specifically designed to meet the unique needs and desires of the knowledgeable driving enthusiast.

Each of nearly 150000 SVT vehicles produced since the 1993 model year has been designed and developed with the four SVT Hallmarks in mind: Performance, Substance, Exclusivity and Value. These hallmarks have driven the SVT Mustang Cobra and the Cobra R, the SVT F-150 Lightning, the SVT Contour, the SVT Focus, Ford GT, Shelby GT500, GT500KR and the F-150 SVT Raptor.

We are proud and passionate about what we do, and we're glad you have made us your choice.

Shelby® GT500® Unique Features



- 5.8L DOHC 32V Supercharged and intercooled V8 engine
- Water-to-oil engine oil cooler (standard)
- Race-track inspired, thermostatically controlled air-to-oil axle, transmission, and engine cooler included on the SVT Track Pack (optional)
- Cast aluminum structural oil pan and piston oil squirters
- Low-restriction, cold air intake system
- SVT tuned 2.75 inch exhaust system with Quad 3.5 inch tips
- Electronically programmable launch control
- TREMEC TR6060 high-torque capacity 6-speed manual transmission
- Short-throw shifter with SVT shift knob
- 260 millimeter twin disc clutch
- One piece carbon fiber driveshaft with front and rear CV joints
- AdvanceTrac® Stability Enhancement System with sport mode specifically calibrated and race track tuned by SVT. Refer to the *Stability Control* chapter in your *Owner's Manual* for more information.
- Limited slip rear differential with 3.31 rear axle ratio
- TORSEN® limited slip differential included on the SVT Performance Package (optional)

Shelby® GT500® Unique Features

- Front brakes: Brembo™ six-piston aluminum calipers with 15 inch x 1.3 inch (380 millimeter x 32 millimeter) vented disc, high air flow shields and high-performance friction material pads
- Rear brakes: 13.8 inch x 0.75 inch (350 millimeter x 19 millimeter) vented disc and high-performance friction material pads
- Electronic over-rev with 7000 rpm maximum
- SVT tuned front and rear suspension and optional electronically selectable dampers by Bilstein™ included on the SVT Performance Package
- 19 inch x 9.5 inch front, 20 inch x 9.5 inch rear forged aluminum wheels with bolt-in valve stems (standard and optional styles)
- P265/40-19 front, P285/35-20 rear directional Goodyear Eagle F1 Supercar G2 R compound tires
- SVT engineered front fascia, grilles, cold air inlet, rear fascia, fog lamps, hood with functional air extractor and aerodynamically tuned front splitter with removable air dam and rear decklid spoiler
- SVT high-speed instrument cluster with track applications dashboard, over-rev and programmable performance shift indicator
- One-touch instrument panel buttons for launch control (LC), electronically selectable dampers (ESD) (if equipped) and electric power assisted steering (EPAS)
- SVT designed seats with over the top stripes and increased lateral support
- Optional race inspired RECARO® front seats with increased lateral support on back and cushion, unique Shelby GT500 trim cover, integrated head restraint, and driver four-way manual adjuster. See the *Seats* section in your *Owner's Manual* for more information
- Leather and Alcantara® wrapped sport steering wheel, leather shift boot, parking brake control boot and handle
- I/P appliques, door panels and lighted scuff plates

Shelby® GT500® Unique Features

Vehicle Specifications



Drivetrain

Item	Description	
Transmission	TREMEC TR6060 6-speed manual with integral clutch housing and 260 mm twin disk clutch	
Driveshaft	1-piece carbon fiber	
Rear axle	8.8 inch solid rear axle with standard limited-slip differential and optional TORSEN® differential, 3.31 ratio	
Gear ratios	<i>Gear</i>	<i>Ratio</i>
	1st	2.66
	2nd	1.82
	3rd	1.30
	4th	1.00
	5th	0.77
	6th	0.50
	Reverse	2.90

Shelby® GT500® Unique Features

Engine Information

Item	Description
Configuration	Longitudinally mounted, 90-degree V8, cast aluminum cylinder block and cylinder heads
Bore x Stroke	3.681 x 4.165 inch (93.5 x 105.8 mm)
Displacement	5810 cc (355 cid)
Compression ratio	9.0:1
Horsepower on 93 octane fuel	662 horsepower @ 6500 rpm
Torque on 93 octane fuel	631 lb-ft torque @ 4000 rpm
Redline	6250 rpm continuous 7000 rpm temporary over-rev
Specific output	112 hp per liter
Valvetrain	Dual overhead chain-driven cams, roller finger followers with hydraulic lash adjustment, ovate-wire valve springs, four valves per cylinder
Ignition	High energy coil on plug ignition with Motorcraft® Iridium-Platinum spark plugs
Fuel system	55 lb/hr injectors with twin high-flow pumps
Mass air sensor	105 mm (4.13 in.) circle
Throttle body	Twin 60 mm (2.36 in.) diameter bore-simultaneously open
Pistons	Shallow-dished forged aluminum
Crankshaft	Forged steel balanced with tungsten inserts
Connecting rods	Forged steel I-beam
Supercharger	Eaton TVS 2300
Exhaust manifolds	Cast high-silicon, molybdenum iron
Exhaust system	Dual stainless steel

Shelby® GT500® Unique Features

Engine Drivebelt Routing

5.8L DOHC Supercharged V8 Engine

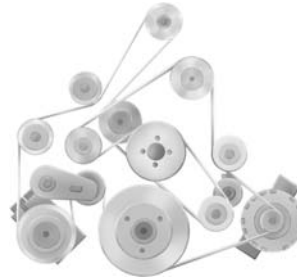

SUSPENSION

Item	Description
Front suspension	MacPherson strut with L-arm front suspension
Rear suspension	8.8 inch solid rear axle with 3-link and Panhard bar and coil springs
Dampers (standard)	TOKICO twin-tube struts and shocks
Dampers (optional)	Electronically Selectable Dampers (ESD) featuring Bilstein DampTronic® select monotube shocks and inverted monotube struts
Coupe stabilizer bars (front)	33.2 x 5.0 mm tubular standard (34.6 x 5.5 mm tubular optional)
Coupe stabilizer bars (rear)	23.0 mm solid standard (25.0 mm solid optional)
Coupe spring rates (standard)	35.0 N/mm front and 33.5 N/mm Rear
Coupe spring rates (optional)	45.0 N/mm front and 35.0 N/mm rear
Convertible stabilizer bars (front)	33.2 x 5.0 mm tubular standard and optional
Convertible stabilizer bars (rear)	23 mm solid standard and optional
Convertible spring rates (standard)	32.5 N/mm front and 30.5 N/mm rear
Convertible spring rates (optional)	34.0 N/mm front and 31.5 N/mm rear

Safety Belts

SAFETY BELT GUIDE (IF EQUIPPED)

 **WARNING:** Position the safety belt guide so that the belt rests across the middle of your shoulder. Failure to adjust the safety belt properly could reduce the effectiveness of the safety belt and increase the risk of injury in a collision.

When in use, the front safety belts can be used with the belt guide. Route the safety belt so that the belt rests across the middle of your shoulder.



Driving your Shelby® GT500®

BREAKING-IN YOUR VEHICLE

Your vehicle requires a break-in period. Drive your new vehicle at least 100 miles (160 km) before performing extended wide open throttle maneuvers and at least 1,000 miles (1,600 km) before performance/competition conditions. Vary your speed frequently in order to give the moving parts a chance to break in.

Alternate calibration

Your Shelby GT500 power train control module (PCM) strategy contains a feature to limit supercharger boost pressure and engine speed to 4,000 rpm for the first five consecutive miles of vehicle operation or 50 engine start/warm up cycles. This feature is enabled prior to shipment. If neither of these conditions have been satisfied prior to customer delivery, full power will not be available.

MANUAL 6-SPEED TRANSMISSION OPERATION

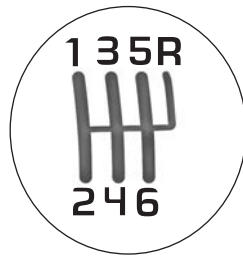

Using the Clutch

The manual transmission has a starter interlock that prevents cranking the engine unless the clutch pedal is fully pressed.

To start the vehicle:

1. Make sure the parking brake is fully set.
2. Press the clutch pedal to the floor, then put the gearshift lever in the neutral position.
3. Start the engine, then press the brake pedal and release the parking brake.

Driving your Shelby® GT500®

4. Move the gearshift lever to first gear, then slowly release the clutch pedal while slowly pressing on the accelerator.

Note: During each shift, the clutch pedal must be fully pressed to the floor and the accelerator fully released. Failure to follow this may cause increased shift efforts, prematurely wear transmission components, or cause gear clash or damage to the transmission. Make sure the floor mat is properly positioned so it doesn't interfere with the full extension of the clutch pedal.

Note: If you attempt to shift when the drive wheels are spinning with a loss of traction, it is possible to cause damage to the transmission. Do not attempt to shift when the drive wheels do not have traction.

Do not drive with your foot resting on the clutch pedal or use the clutch pedal to hold your vehicle at a standstill while waiting on a hill. These actions will reduce the life of the clutch.

Your vehicle is equipped with a twin disc clutch. Due to the high performance of the powertrain, a certain amount of noise from the transmission is normal.

Clutch Protection

Your vehicle is equipped with an electronic powertrain feature to reduce clutch damage. When excessive clutch slip is detected at a high power level, the powertrain control module will limit torque to reduce damage to the clutch. Full power is restored as soon as the clutch is fully engaged. This feature is calibrated in a way that does not interfere with normal driving and does not impede maximum acceleration capability.

Driving your Shelby® GT500®

Recommended Shift Speeds for Maximum Fuel Economy

Upshift according to the following chart:

Upshifts when accelerating	
Shift from:	
1 - 2	11 mph (18 km/h)
2 - 3	18 mph (29 km/h)
3 - 4	25 mph (40 km/h)
4 - 5	30 mph (48 km/h)
5 - 6	43 mph (69 km/h)

Operating at High Speeds

Equipped with the SVT Track Pack, your SVT vehicle is capable of sustained high speeds and track day driving. All Shelby GT500's are equipped with tires rated for the vehicle's maximum speed. Remember to drive safely, obey all traffic laws and only operate your SVT vehicle at high speeds at locations equipped and designed to do so safely. Before operating your vehicle at high speeds, follow these guidelines.

- Verify your tires have the correct tire pressures (see *Tires* in this supplement).
- Inspect wheels and tires for wear and damage. Replace any damaged wheels or tires.
- Do not operate your vehicle at high speeds with more than two passengers or while carrying cargo.

Driving your Shelby® GT500®

SHELBY GT500 INSTRUMENT CLUSTER

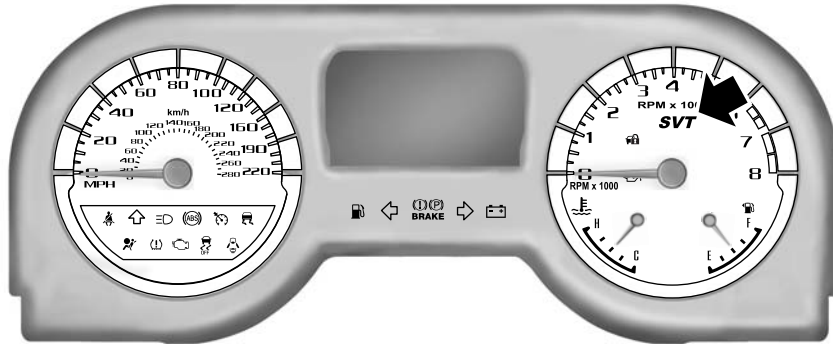

Performance Shift Indicator

When activated, the programmable shift indicator provides a visual (SHIFTLAMP) and may include an audible (SHIFTTONE) cue to shift to the next highest gear at an engine rpm specified by the driver.

The SHIFTLAMP feature uses the SVT logo on the tachometer to notify you when the desired shiftpoint is reached. The SVT symbol is backlit in red under normal driving conditions (SHIFTLAMP OFF). When the SHIFTLAMP is set to ON, the red backlighting is turned off and the SVT logo will turn bright orange when the desired shift point is reached.

The SHIFTTONE feature uses an audible tone to notify you when the desired shiftpoint is reached.

SHIFTLAMP and SHIFTTONE can be used separately, together, or turned off completely.

The SHIFTPPOINT can be adjusted from 1500-7000 rpm in the Settings/Vehicle menu. See the *Information Displays* chapter in your *Owner's Manual* for more information.

Unique Instrument Cluster Lighting

For instructions on how to set the instrument cluster display color or MyColor®, refer to the *Information Displays* chapter in the *Owner's Manual*.

Driving your Shelby® GT500®

VIRTUAL GAUGES

VACUUM inHG / BOOST psi

Displays the vacuum or boost pressure.

Note: This gauge moves frequently and will sweep quickly through the vacuum and boost range as the driver presses and releases the accelerator. This is normal behavior.



TRACK APPS

Dashboard Screen

Displays AdvanceTrac®, steering feel, damper control, and launch control states. See the *Information Displays* chapter of your *Owner's Manual* for more information on Track Apps.

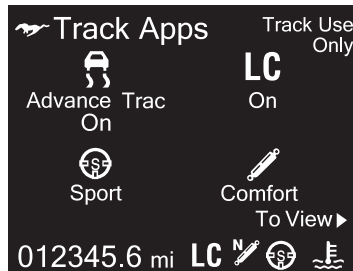

Driving your Shelby® GT500®

ADVANCETRAC® STABILITY ENHANCEMENT SYSTEM

The AdvanceTrac® stability enhancement system provides eight modes of operation for various driving conditions. The system integrates braking, steering and powertrain systems using ABS, traction control, EPAS and launch control optimizing the performance for all driving conditions.

AdvanceTrac® Sport Mode

The AdvanceTrac® system provides an available sport mode specially calibrated for the GT500's unique performance characteristics. This can be selected utilizing the stability control off switch. See the *Driving* section of the *Owner's Manual* for more information.

Sport mode is not intended for use on public roadways as this mode provides less AdvanceTrac® system intervention than when the default ESC and traction control systems are on. Sport mode will allow more spirited driving while the AdvanceTrac® system is still enabled.

Driving your Shelby® GT500®

AdvanceTrac® features when using launch control		
Launch control button	AdvanceTrac button function	AdvanceTrac setting reverts to enabled with key cycle.
	Anti-Lock Braking (ABS) remains on in all modes. Disabled (Press and hold with vehicle stopped and foot on brake)	
	Traction control OFF AdvanceTrac Enabled (Single press)	SPORT (Foot on brake and double tap)
OFF	Mode 1 • AdvanceTrac On Normal • TC On Normal • LC OFF	Mode 2 • AdvanceTrac On Normal • TC OFF • LC OFF
ON	Mode 3 • AdvanceTrac SPORT • TC On SPORT • LC OFF	Mode 4 • AdvanceTrac OFF • TC OFF • LC OFF
	Mode 5 • AdvanceTrac On Normal • TC On Drag Start Calibration • LC ON	Mode 6 • AdvanceTrac On Normal • TC OFF • LC RPM ONLY
	Mode 7 • AdvanceTrac SPORT • TC On Drag Start Calibration • LC ON	Mode 8 • AdvanceTrac OFF • TC OFF • LC UNAVAILABLE
Launch control setting does not turn ON/OFF with key cycle. Launch control engine RPM setpoint range available in 100 RPM increments. Launch control displays ACTIVE (mode 5 and 7) or RPM ONLY (mode 6) during PCM control of the engine RPM.		

Driving your Shelby® GT500®

AdvanceTrac feature notes	
<p>Electric power assist steering (EPAS) can be used in COMFORT, NORMAL or SPORT settings. EPAS will revert to SPORT and display SPORT-LOCKED mode when AdvanceTrac® SPORT or OFF is selected.</p> <p>If equipped with optional electronically selectable dampers (ESD), damping setting does not turn ON/OFF with key cycle.</p> <p>NORMAL and SPORT damping settings are independent of AdvanceTrac®, launch control and EPAS steering settings.</p>	
AdvanceTrac Mode Descriptions and Usage	
Mode 1	<p>• Street and High Performance Driving</p> <p>• AdvanceTrac NORMAL with All Weather Calibration</p>
Mode 2	<p>• Drag strip burn-out with Traction Control Off</p> <p>• AdvanceTrac NORMAL with All Weather Calibration</p>
Mode 3	<p>• Road Course</p> <p>• AdvanceTrac and Traction Control SPORT Calibration</p>
Mode 4	<p>• All AdvanceTrac® Systems Off (ABS ON)</p>
	<p>No action is required by driver; optimal calibration for standard and high performance driving.</p>
	<p>Allows the driver to spin the tires in a straight line without electronic intervention.</p>
	<p>Provides enhanced control by increasing AdvanceTrac thresholds for high speed road course driving.</p>
	<p>No electronic intervention for AdvanceTrac or traction control systems.</p>
	<p>Default - No action by driver</p>
	<p>Single tap AdvanceTrac button</p>
	<p>Double tap AdvanceTrac button with foot on brake</p>
	<p>While stopped, press and hold AdvanceTrac button.</p>

Driving your Shelby® GT500®

AdvanceTrac Mode Descriptions and Usage			
Mode 5	<ul style="list-style-type: none"> • Launch Control On • AdvanceTrac NORMAL with All Weather Calibration 	Enables launch control to maximize straight line acceleration while providing NORMAL AdvanceTrac dynamic control.	Press launch control button.
Mode 6	<ul style="list-style-type: none"> • Two stage RPM control with Traction Control Off • AdvanceTrac NORMAL with All Weather Calibration 	Enables an engine rev limiter, if vehicle is stationary, with no traction assist for drag strip usage. Provides NORMAL AdvanceTrac dynamic control.	Press launch control button and single tap AdvanceTrac button.
Mode 7	<ul style="list-style-type: none"> • Launch Control On • Advance Trac and Traction Control SPORT Calibration 	Enables launch control to maximize straight line acceleration while providing SPORT AdvanceTrac dynamic control.	Press launch control button and double tap AdvanceTrac button with foot on brake.
Mode 8	<ul style="list-style-type: none"> • All AdvanceTrac Systems Off (ABS on) with Launch Control Available if AdvanceTrac button is pressed 	No electronic intervention for AdvanceTrac or Traction Control systems. Launch control is unavailable	Press launch control button. While stopped, press and hold AdvancTrac button.
Recommended driving modes			
Street		All drivers - modes 1 and 2	—
Race track		Novice - mode 3	Expert - mode 4
Drag strip		Novice - mode 5	Expert - modes 6, 7 and 8

Driving your Shelby® GT500®

BRAKES

Your vehicle is equipped with a brake system designed for high speed and superior fade resistance. You may notice occasional brake squeal and elevated levels of brake dust. This is normal and does not affect brake system performance.

Use Motorcraft® Wheel and Tire Cleaner to maintain your wheels. Refer to your *Owner's Manual* for information on other cleaning products and vehicle care.

LAUNCH CONTROL

Note: This feature is intended for off road use only where consistent acceleration is desired. It is not intended for cold, wet or slippery conditions.

Launch control can be turned on and off with the LC button, or in the Track Apps menu using the 5-way buttons. RPM setpoint can only be changed in the Track Apps menu using the 5-way button. Detailed description of operation modes and recommended usage is outlined in the AdvanceTrac section.

Launch control is engineered to be used with the original equipment provided on your GT500. Any modifications to the vehicle may adversely affect the function or performance.

The launch control feature is integrated with AdvanceTrac® and the engine controls system to maximize traction from a standing start acceleration in a straight line. It provides a unique drag start traction calibration specifically designed for high grip surfaces. This feature lets you set and hold the desired launch RPM depending on tire temperature, surface condition or weather. To function properly, AdvanceTrac® must be ON or in the SPORT mode. If launch control is ON and traction control is OFF, then the system provides an engine rev control (two-step) only and no traction management.

Refer to the AdvanceTrac® section to identify the traction modes and recommended usage.

Driving your Shelby® GT500®

To use launch control:

1. Start from a complete stop with the steering wheel pointed straight ahead.
2. Press the LC button or go to TRACK APPS>LAUNCH CONTROL>LAUNCH CONTROL>ON
3. Fully press the clutch.
4. Select first gear.
5. Press the accelerator to the floor. The engine will hold set RPM.
6. Quickly and smoothly release the clutch while maintaining pressure on the accelerator.
7. Upshift normally.



To change the RPM setting:

1. Go to TRACK APPS>LAUNCH CONTROL>RPM Setting.
2. Choose the desired launch RPM.
3. Follow the on-screen prompts.

OPTIONAL SVT TUNED ELECTRONICALLY SELECTABLE DAMPERS (ESD)

Press the center button to select the damper setting or through the information display. See *Information Displays* in the *Owner's Manual* for more information.



If equipped with the SVT Performance Package, your vehicle's dampers can be set in either NORMAL or SPORT mode. The NORMAL setting is optimized for most street and daily driving. The SPORT mode is race track tuned and should be selected for optimal performance when ride comfort is of less concern.

Driving your Shelby® GT500®

STEERING

Your vehicle is equipped with an electric power-assisted steering system. The system's settings are tuned by SVT and integrated with the vehicle dynamics.

Press the right button to select the damper setting or through the information display. See *Information Displays* in the *Owner's Manual* for more information.



- **STANDARD:** Default factory setting.
- **SPORT:** Slightly higher effort required for steering with more road force felt through the steering wheel.
- **COMFORT:** Slightly less effort required for steering with less road force felt through the steering wheel.

After selecting the desired setting, you may feel a soft feedback bump in the steering wheel when the changeover occurs.

Note: If the battery is disconnected or removed, the steering setting will default to STANDARD.

Note: If the AdvanceTrac system is in SPORT mode or OFF, the steering will default to SPORT.

See the *Information Displays* chapter in the Owner's Manual.

ENGINE OVER-REV

Note: Engine torque and maximum rpm are limited until coolant temperature reaches 170°F (77°C). Warm up is indicated when the redline indicator band starting point changes from 6250 rpm to 7000 rpm.

Your vehicle is equipped with an over-rev feature to increase the performance range of your Shelby GT500. When conditions permit, over-rev is indicated on the tachometer with redline marked at 7000 rpm. If conditions limit over-rev accessibility, the band is illuminated red from 6250 rpm to 7000 rpm.

Driving your Shelby® GT500®

Once the engine is warm, the over-rev feature allows eight seconds above 6250 rpm up to 7000 rpm. If the eight second time limit is exceeded, the maximum engine rpm is reduced to 6250 rpm until both of the following occurs:

- Engine is operated for at least 15 seconds below 6000 rpm
- Engine rpm falls below 5000 rpm.

Do not operate the engine at high rpm and low load for sustained periods of time, as damage may occur.

GROUND CLEARANCE



Your vehicle is designed for high speed capability and has been aerodynamically tuned to reach 200 mph (322 km/h) when properly equipped. Some of the aerodynamic tuning has been achieved with the lower front air dam, which is attached below the front splitter. The lower front air dam is removable with basic tools to suit your driving conditions, especially if they include steep driveway angles, rough roads, high curbs or harsh climates.

Since ground clearance is reduced, use caution when approaching curbs or curb stops from the front and rear as vehicle damage will occur. Additionally, when crossing speed bumps or driveway curbs, SVT recommends approaching at a 45 degree angle to reduce the risk of vehicle damage.

The Shelby GT500 carries the same warranty as other Ford Mustang models. Damage caused by accidents, collision or objects striking the vehicle (including driving through a car wash) or misuse of the vehicle, such as driving over curbs, overloading, racing or using the vehicle as a permanent stationary power source is not covered under the new vehicle limited warranty. See the Warranty Guide for complete information.

Driving your Shelby® GT500®

DRIVING YOUR SHELBY GT500 THROUGH WATER

The Ford Shelby GT500 has aerodynamic devices attached to the underbody designed to help control airflow for superior performance. Therefore, the driver must be especially careful to avoid driving through deep or standing water. If driving through deep or standing water is unavoidable, do not exceed 10 mph (16 km/h). Never drive through water that is higher than the bottom of the wheel rims. Water may enter through the air intake due to the vacuum generated in the engine. Damage caused by the intake of water in the engine is not covered by the warranty.

WASHING YOUR SHELBY GT500

Do not drive your vehicle through an automated, commercial car wash due to the vehicle's low ground clearance, tire width and track. Wash your vehicle by hand, or by using a touchless commercial wash with no mechanical tracks on the floor. Do not use a power washer or high pressure wand on the striped surfaces or stripe edges. Refer to the *Owner's Manual* for information on cleaning products and vehicle care.

To maintain proper cooling and aerodynamics at high speeds, your vehicle has heat exchangers integrated with the front fascia designed to maximize performance.

Note: Do not use a power washer or high powered spray nozzle as damage to the fins could occur.

Note: For heavy accumulation of debris or dirt, clean with a non-metallic soft bristle car wash brush and warm soapy water as needed.

Wheels and Tires

WHEELS

Your SVT vehicle is equipped with unique wheels matched to the tires. These wheels are more susceptible to damage due to their diameter, width and low profile tires. To avoid damage to your wheels:

- Maintain proper tire pressure (see *Tires* in this supplement).
- Do not drive your vehicle through an automated, commercial car wash due to the vehicle's low ground clearance, tire width and track. Wash your vehicle by hand, or by using a touchless commercial wash with no mechanical tracks on the floor. Do not use a commercial or high pressure wand on the striped surfaces.
- When installing wheels, always torque lug nuts to specification with a torque wrench.
- Inspect your wheels for damage on a regular basis. If a wheel is damaged, replace it immediately.
- In the event that you encounter an abnormally harsh impact, inspect the outer diameter of your wheels, both inside and out, for damage.

Wheel Lug Nut Torque Specifications



WARNING: When a wheel is installed, always remove any corrosion, dirt or foreign materials present on the mounting surfaces of the wheel or the surface of the wheel hub, brake drum or brake disc that contacts the wheel. Make sure that any fasteners that attach the rotor to the hub are secured so they do not interfere with the mounting surfaces of the wheel. Installing wheels without correct metal-to-metal contact at the wheel mounting surfaces can cause the wheel nuts to loosen and the wheel to come off while the vehicle is in motion, resulting in loss of control.

Retighten the lug nuts to the specified torque at 500 miles (800 km) after any wheel disturbance (tire rotation, changing a flat tire, wheel removal, etc.).

Bolt size	Wheel lug nut torque*	
	ft-lb	N•m
1/2 x 20	100	135

* Torque specifications are for nut and bolt threads free of dirt and rust. Use only Ford recommended replacement fasteners.

Wheels and Tires

TIRE INFORMATION

Your SVT vehicle is equipped with unique wheels and tires designed to enhance performance. To continue providing this performance, extra care must be taken when operating and maintaining your vehicle.

Tires	P265/40-19 front, P285/35-20 rear tires
Wheels	19 in. x 9.5 in. front, 20 in. x 9.5 in. rear forged aluminum wheels

Tires

Your SVT vehicle is equipped with low profile, high performance tires that are designed to optimize the driving dynamics you expect in a SVT vehicle. These tires are not optimized for off-road or winter (snow or cold weather) performance, and their ride, noise and wear characteristics are different than non-performance tires. Also, because of their lower profile, the tires are more susceptible to damage due to potholes and rough roads. To make sure that your tires perform as intended, it is important that you maintain your tires properly:

- The Shelby GT500 original equipment tires are optimized for performance in both wet and dry conditions. Ford does not recommend using the original equipment tires when temperatures drop to approximately 40°F (5°C) or below (depending on tire wear and environmental conditions) or in snow/ice conditions.
- The Shelby GT500 P265/40-19 front, P285/35-20 rear directional tires were designed for track use and may exhibit significantly reduced tread life and increased tire noise compared to the standard equipment tires under normal driving conditions. Increasing the front camber settings beyond the factory settings may further accelerate tread wear and induce tire noise.
- **Note:** Do not use tire chains on the original wheels and tires of your vehicle. The use of any type of tire chain on these tires may damage your vehicle.
- For tire pressures, see the placard located on the B-pillar inside the driver's door.
- Always maintain your tire pressures according to the tire information placard on the driver's door jamb, using an accurate gauge.

Wheels and Tires

- Tire pressures are specified cold and should be checked after the vehicle has been parked for at least 3 hours. Do not reduce pressure of warm tires.
- Check your tire pressure often to maintain it properly. Tire pressure can diminish over time and fluctuate with temperature.
- Do not overload your vehicle. Maximum vehicle and axle weights are listed on the tire information placard.
- Extra caution should be taken when operating the vehicle near its maximum load, including assuring proper tire pressure and reducing speeds.
- Extra caution should be taken when operating on rough roads to avoid impacts that could cause tire damage.
- In the event that you encounter an abnormally harsh impact, inspect your tires for damage.
- Inspect your tires for damage on a regular basis. If a tire is damaged, replace it immediately.
- Proper suspension alignment is critical for maximum performance and optimal tire wear. If you notice uneven tire wear, have your alignment checked.
- Rotate tires as recommended in the following section *Tire rotation*.
- When replacing tires, the only way to maintain original performance is to use the original equipment tire. If a different tire is used, it should be the same size, speed rating and load rating and be replaced as a set of four. Never mix tire brands.



WARNING: For vehicles equipped with performance package tires (P265/40-19 front, P285/35-20 rear), only replace wheels and tires with the EXACT original brand, size and construction tire with which your vehicle was originally equipped. Use of any other wheel/tire combinations, even with identical size ratings, may result in insufficient running clearances, tire rubbing and eventual puncture. Loss of tire pressure could lead to a loss of vehicle control leading to serious injury or death.

Wheels and Tires

Summer Tires

The Shelby GT500 is equipped with D.O.T. approved ultra high performance summer tires with track capability. The rubber compounds used in these tires lose flexibility and may develop surface cracks in the tread area at temperatures below 20°F (-7°C). Always store your tires indoors at temperatures above 20°F (-7°C). If the tires have been subjected to 20°F (-7°C) or less, warm them in a heated space to at least 40°F (5°C) for at least 24 hours before installing them on a vehicle, or moving the vehicle with the tires installed, or checking tire inflation. Do not place tires near heaters or heating devices used to warm the room where the tires are stored. Do not apply heat or blow heated air directly on the tires. Always inspect the tires after storage periods and before use as outlined in the *Owner's Manual*. Ford does not recommend using these high performance summer tires when temperatures drop to approximately 40°F (5°C) or below, or in snow or ice conditions.

Winter Driving

The original equipment tires on your SVT vehicle are designed for maximum performance in dry and wet summer conditions. They are not designed for winter use on ice or snow and cannot be used with snow chains. If you will be operating your vehicle in these conditions, winter or all-season tires must be used.

- Use winter tires with a V speed rating and a 93 load index or higher for all models. You may also use P255/40R19 winter tires with a V speed rating and a 93 load index and 19 inch wheels from the 2010-2012 model year Shelby GT500. Using these wheels will provide adequate brake and suspension clearance.
- Do not use a winter tire with less than a V speed rating, and even with clear, dry driving conditions do not operate your vehicle above posted speed limits while using winter tires. Never perform high speed driving with winter tires.

Please call the Ford Performance Info Center at 1-800-FORD-SVT (367-3788) for specific winter tire recommendations.

Tire Rotation

Note: Your Shelby GT500 tires (P265/40-19 front, P285/35-20 rear) are directional. Tire rotation is not recommended for directional tires.

Note: If your tires show uneven wear, ask an authorized dealer to check for and correct any wheel misalignment, tire imbalance or mechanical problems.

Roadside Emergencies

WRECKER TOWING

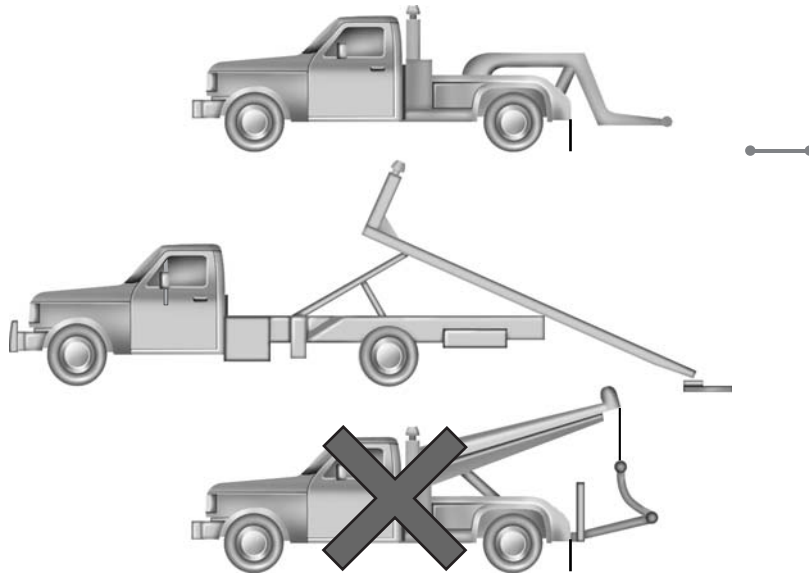

If you need to have your vehicle towed, contact your roadside assistance center or a professional towing service.

It is recommended that your vehicle be towed with a wheel lift and dollies or with flatbed equipment. When towing with a flatbed, 4x4 blocks must be used when loading/unloading your vehicle. Do not tow with a slingbelt. Ford Motor Company has not approved a slingbelt towing procedure.

Note: If the vehicle is towed by other means or incorrectly, vehicle damage may occur.

Roadside Emergencies

Transportation Instructions

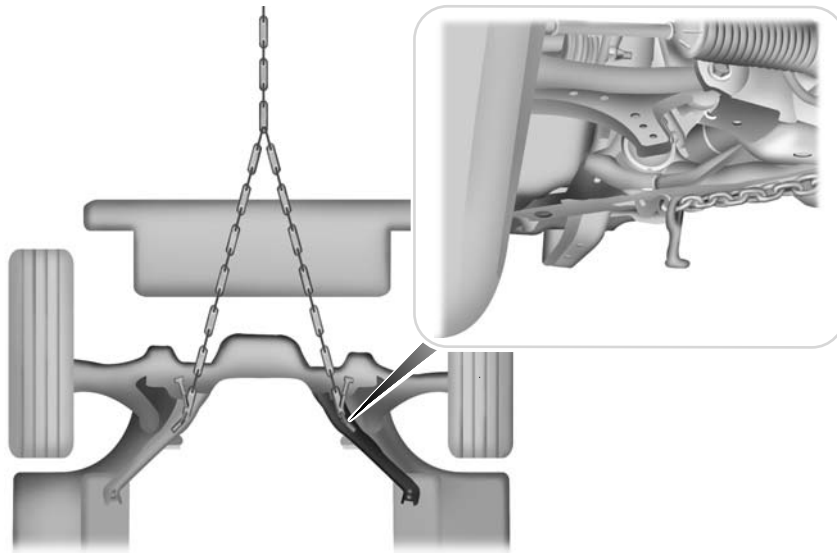

When towing the vehicle, make sure that you use two mini J hooks and attach them to the crossmember oblong holes as shown to winch the vehicle onto the flatbed. The T-hook slot should be used to tie-down the vehicle to the wrecker. Other methods may damage the vehicle.

Roadside Emergencies

Wheel Lift

Preferred method



Alternate method



When towing the Shelby GT500, for front loading, the front tires must be 16 inches (41 centimeters) higher than the rear.

When towing the vehicle from the rear, wheel dollies must be used. The rear tires must be 12 inches (31 centimeters) higher than the front tires. Caution should be used when traveling over rough roads, railroad crossings, or driveway approaches to prevent any damage.

Roadside Emergencies

Flatbed

Preferred method

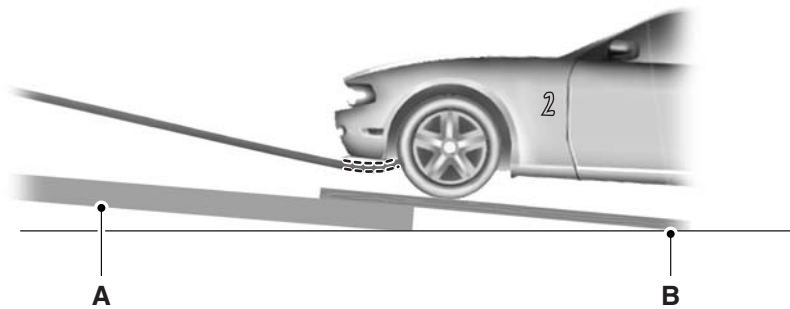

A. Tow vehicle ramp

B. Wooden ramp

Use 2 inch x 8 inch x 8 foot wooden ramps to load the vehicle.

The following diagram illustrates the maximum ramp angle allowable to load your vehicle on a flatbed. Vehicle damage may occur with greater angles.

Blocks or ramps must be used to achieve appropriate undercarriage clearances.

Roadside Emergencies

Alternate method

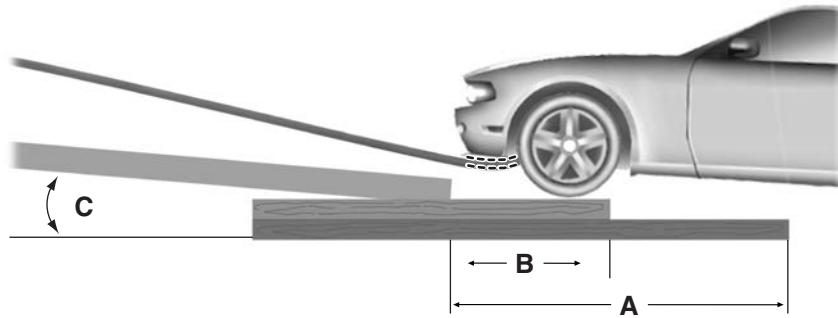

- A. 36 inches (91 centimeters) 4 inch x 4 inch loading block
- B. 18 inches (46 centimeters) 4 inch x 4 inch loading block
- C. 11.5 degrees maximum

Maintenance

5.8L DOHC SUPERCHARGED V8 ENGINE

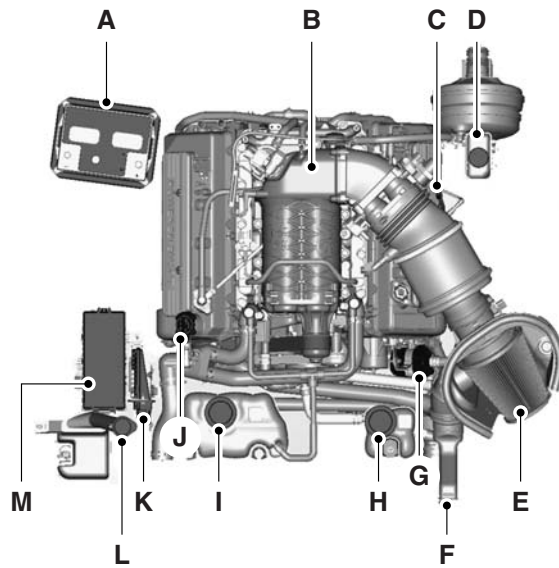

- A. Battery
- B. Supercharger
- C. Engine oil dipstick
- D. Brake fluid reservoir
- E. Air filter assembly
- F. Cold air induction system
- G. Electric intercooler pump
- H. Intercooler coolant reservoir
- I. Engine coolant reservoir
- J. Engine oil filler cap
- K. Powertrain control module
- L. Windshield washer reservoir
- M. Power distribution box

Maintenance

ENGINE OIL RECOMMENDATION

Use Motorcraft® SAE 5W-50 full synthetic or an equivalent SAE 5W-50 full synthetic oil meeting Ford specification WSS-M2C931-B.

Do not use supplemental engine oil additives, cleaners or other engine treatments. They are unnecessary and could lead to engine damage that is not covered by Ford warranty.

Change your engine oil and filter according to the appropriate schedule listed in the *scheduled maintenance information*.

CHECKING THE ENGINE OIL

Refer to the *scheduled maintenance information* for the appropriate intervals for checking the engine oil.

1. Make sure the vehicle is on level ground.
2. Turn the engine off and wait 15 minutes for the oil to drain into the oil pan.
3. Set the parking brake and make sure the gearshift is securely latched in first gear.
4. Open the hood. Protect yourself from engine heat.

Maintenance

5. Locate and carefully remove the engine oil level dipstick.
6. Wipe the dipstick clean. Insert the dipstick fully, then remove it again.
 - If the oil level is between the lower and upper holes, the oil level is acceptable. DO NOT ADD OIL.
 - If the oil level is below the lower hole, add enough oil to raise the level within the lower and upper holes.
 - The maximum oil level is between the upper hash mark and the upper hole. Oil levels above this range may cause engine damage. Some oil must be removed from the engine by an authorized dealer.



7. Put the dipstick back in and make sure it is fully seated.

ENGINE AND INTERCOOLER COOLANT

The concentration and level of engine coolant should be checked at the mileage intervals listed in the *scheduled maintenance information*.

Note: Make sure that the level is between the MIN and MAX marks on the engine and intercooler coolant reservoirs.

Note: For best results, coolant concentration should be tested with a refractometer such as Rotunda tool 300-ROB75240E available from your dealer. Ford does not recommend the use of hydrometers or coolant test strips for measuring coolant concentrations.

Note: Coolant expands when it is hot. The level may extend beyond the MAX mark. If the level is at the MIN mark, add coolant immediately.

Be sure to read and understand *Precautions* in your *Owner's Manual*. If the coolant has not been checked at the recommended interval, the engine or intercooler coolant reservoir may become low or empty. If the reservoir is low or empty, add coolant to the reservoir. Refer to *Adding coolant* in this chapter.

Maintenance

Note: Automotive fluids are not interchangeable; do not use engine coolant/antifreeze or windshield washer fluid outside of its specified function and vehicle location. For more information about engine coolant, see the *Maintenance* chapter of the *Owner's Manual*.

Adding Engine Coolant



WARNING: Do not add coolant when the engine is hot. Steam and scalding liquids released from a hot cooling system can burn you badly. Also, you can be burned if you spill coolant on hot engine parts.



WARNING: Do not put coolant in the windshield washer fluid container. If sprayed on the windshield, coolant could make it difficult to see through the windshield.



WARNING: To reduce the risk of personal injury, make sure the engine is cool before unscrewing the coolant pressure relief cap. The cooling system is under pressure; steam and hot liquid can come out forcefully when the cap is loosened slightly.



WARNING: Do not add coolant further than the MAX mark.

Note: Do not use stop leak pellets, cooling system sealants, or additives as they can cause damage to the engine cooling or heating systems. This damage would not be covered under your vehicle's warranty.

Note: During normal vehicle operation, the engine coolant may change color from orange to pink or light red. As long as the engine coolant is clear and uncontaminated, this color change does not indicate the engine coolant has degraded nor does it require the engine coolant to be drained, the system to be flushed, or the engine coolant to be replaced.

- DO NOT MIX different colors or types of coolant in your vehicle. Make sure the correct coolant is used. Mixing of engine coolants may harm your engine's cooling system. The use of an improper coolant may harm engine and cooling system components and may void the warranty.

Maintenance

A large amount of water without engine coolant may be added, in case of emergency, to reach a vehicle service location. In this instance, the cooling system must be drained, chemically cleaned with Motorcraft® Premium Cooling System Flush, and refilled with prediluted coolant as soon as possible. Water alone (without engine coolant) can cause engine damage from corrosion, overheating or freezing.

- **Note:** Do not use alcohol, methanol or brine or any engine coolants mixed with alcohol or methanol antifreeze (coolant). Alcohol and other liquids can cause engine damage from overheating or freezing.
- **Note:** Do not add extra inhibitors or additives to the coolant. These can be harmful and compromise the corrosion protection of the engine coolant.

Unscrew the cap slowly. Any pressure will escape as you unscrew the cap.

Add prediluted engine coolant meeting the Ford specification. See *Capacities and Specifications* for more information. Whenever coolant has been added, the coolant level in the coolant reservoir should be checked the next few times you drive the vehicle. If necessary, add enough prediluted coolant to bring the coolant level to the proper level and concentration.

Coolant and Intercooler Refill Procedure

The following procedure should be used when refilling the cooling system after it has been drained or become extremely low.

1. Remove the pressure relief cap from the coolant reservoir as previously outlined.
2. Slowly add prediluted coolant to the coolant reservoir until the coolant level is between the MIN and MAX marks on the reservoir.
3. Reinstall the pressure relief cap.
4. Start and idle the engine until the upper radiator hose is warm (this indicates the thermostat is open and coolant is flowing through the entire system).
5. Shut the engine off and let it cool.
6. Remove the pressure relief cap from the coolant reservoir as previously outlined.

Maintenance

7. Add prediluted coolant to the coolant reservoir until the coolant level is between the MIN and MAX marks on the reservoir.
8. Reinstall the pressure relief cap.
9. Check the coolant level in the reservoir before you drive your vehicle the next few times (with the engine cool).
10. If necessary, add prediluted coolant to the coolant reservoir until the coolant level is between the MIN and MAX marks on the reservoir.

Whenever coolant has been added, the coolant level in the coolant reservoir should be checked the next few times you drive the vehicle. If necessary, add prediluted coolant to bring the coolant level to the proper level.

If you have to add more than 1.0 quart (1.0 liter) of coolant per month, have your dealer check the cooling system. Your cooling system may have a leak. Operating an engine with a low level of coolant can result in engine overheating and possible engine damage.

ENGINE SPARK PLUG INTERVAL

To keep your high performance engine operating at peak performance, the spark plug service interval is every 45,000 miles (72,000 kilometers). See the Motorcraft® Part Numbers chart for the specific spark plug application.

OCTANE RECOMMENDATIONS

Premium unleaded gasoline with an (R+M)/2 octane rating of 91 or higher is required. SVT recommends using unleaded gasoline with octane rating of 93 or higher for optimal performance of this vehicle.

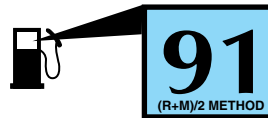

Recommended fuel is an important part of the proper maintenance and optimal performance of this vehicle. The use of gasoline with an octane rating lower than 91 can lead to severe mechanical damage to your vehicle, may degrade vehicle performance, and may affect your warranty coverage.

Maintenance

AIR FILTER

 **WARNING:** To reduce the risk of vehicle damage and/or personal burn injuries do not start your engine with the air cleaner removed and do not remove it while the engine is running.

Refer to *scheduled maintenance* for the appropriate intervals for changing the air filter element.

When changing the air filter element, use only the Motorcraft® air filter element listed. Refer to *Motorcraft part numbers* in the *Capacities and Specifications* chapter.

Changing the Air Filter Element

1. Loosen the air filter clamp bolt enough to allow the air filter to slip off the air filter housing easily.
2. Slip the air filter off from the air filter housing.
3. Wipe the air filter housing clean to remove any dirt or debris.
4. Install the new air filter taking care not to damage the air filter element. Align the tab on the closed end of the filter with the notch in the air filter housing.
5. Tighten the air filter clamp bolt.



Capacities and Specifications

MOTORCRAFT PART NUMBERS

Component	5.8L Supercharged V8 engine
Air filter element	FA-1896
Fuel filter	FG-1083
Battery	BXT-96R-590
Oil filter	FL-820S
Spark plugs	CGSF-12YP 0.033 - 0.037 inches (0.85 - 0.95 mm)

Capacities and Specifications

TECHNICAL SPECIFICATIONS

Item	Capacity	Ford part name or equivalent	Ford part number / Ford Specification
Brake fluid	Between MIN and MAX lines on reservoir	Motorcraft® High Performance DOT 3 Motor Vehicle Brake Fluid	PM-1-C / WSS-M6C62-A or WSS-M6C65-A1
Engine oil without cooler (with filter change)	8.5 quarts (8.0L)	Motorcraft® 5W-50 Full Synthetic Motor Oil	X0-5W50-QGT / WSS-M2C931-B
Engine oil with cooler (with filter change)			
Engine coolant ¹	21.1 quarts (20.0L)	Motorcraft® Orange Antifreeze/Coolant Prediluted	VC-3DIL-B (US) CVC-3DIL-B (Canada) / WSS-M97B44-D2
Intercooler coolant ¹	5.4 quarts (5.1L)		
Rear axle lubricant without cooler ²	4 pints (1.9L)	Motorcraft® SAE 75W-85 Premium Synthetic Hypoid Gear Lubricant	XY-75W85-QL / WSS-M2C942-A
Rear axle lubricant with cooler ²	6 pints (2.8L)		
Rear axle fluid friction modifier without cooler	4 oz. (118 ml)	Additive Friction Modifier	XL-3 EST-M2C118-A
Rear axle fluid friction modifier with cooler	6 oz. (177 ml)		
Fuel tank	16.0 gallons (60.5L)	—	—

42

Capacities and Specifications

Item	Capacity	Ford part name or equivalent	Ford part number / Ford Specification
Transmission fluid without cooler ^{3,4}	3.6 quarts (3.4L)	Motorcraft® MERCON® V ATF	XT-5-QM / MERCON® V
Transmission fluid with cooler ^{3,4}	4.1 quarts (3.9L)		
Windshield washer fluid	Fill as required	Motorcraft® Premium Windshield Washer Concentrate (US) / Premium Quality Windshield Washer Fluid (Canada)	ZC-32-A (US) CXC-37-(A, B, D, and F) (Canada) / WSB-M8B16-A2 / - -

¹Add the coolant type originally equipped in your vehicle.

²Rear axle lubricants do not need to be checked or changed unless a leak is suspected, service is required or the axle assembly has been submerged in water. The axle lubricant should be changed any time the rear axle has been submerged in water. For vehicles with a cooler, the axle pump must be running to perform the service refill.

Fill 1/4-9/16 inch (6-14 millimeters) below bottom of fill hole.

³The TREMEC 6060 6-speed manual transmission on your Shelby GT500 uses MERCON® V automatic transmission fluid. Make sure that the correct MERCON® V ATF automatic transmission fluid is used as indicated on the label on your transmission.

⁴Service refill capacity is determined by filling the transmission to the bottom of the filler hole with the vehicle on a level surface. For vehicles with a transmission cooler, the engine must be running, the clutch pedal must be released, and the transmission must be in neutral to perform the service refill.

Capacities and Specifications

USING THE RIGHT BULBS

Function	Trade number
Park lamp, turn lamp, side marker (front)	3156K
Fog lamp	PS24N

Warranty Coverage

WARRANTY COVERAGE

The Shelby GT500 carries the same warranty as other Ford Mustang models. This information is covered in its entirety in the warranty information.

Warranty service for the Shelby GT500 or any SVT vehicle can be obtained at any Ford dealer nationwide.

SVT does not recommend modifying or racing SVT vehicles, as they are designed and built to be driven as delivered from the factory. The warranty information discusses vehicle usage and the installation of aftermarket parts and their effect on warranty coverage.

In the event the vehicle is intended for track use, and the loss of warranty coverage is not a concern, SVT recommends the car is equipped with the SVT Track Pack.

Additionally, perform multi-point inspection and the maintenance outlined in the 150,000 mile (240,000 kilometer) normal maintenance schedule of the *scheduled maintenance* before and after track use. Refer to the vehicle service manual for removal and installation procedures. Replace with Genuine Ford and Motorcraft® service parts as needed.

These modifications may not necessarily protect your engine from damage in competition conditions. Subjecting your vehicle to competition conditions even with these proposed modifications may render repairs non-reimbursable under the warranty.

Scheduled Maintenance Guide

GENERAL MAINTENANCE INFORMATION

Why Maintain Your Vehicle?

Carefully following the maintenance schedule helps protect against major repair expenses resulting from neglect or inadequate maintenance and may also help to increase the value of your vehicle when you sell or trade it. Keep all receipts for completed maintenance with the vehicle.

Regular maintenance intervals for your vehicle have been established based upon rigorous testing. It is important that you have your vehicle serviced at the proper times. These intervals serve two purposes; one is to maintain the reliability of your vehicle and the second is to keep your cost of owning the vehicle down.

It is your responsibility to see that all scheduled maintenance is performed and that the materials used meet the specifications identified in the *Capacities and Specifications* chapter. Failure to perform scheduled maintenance invalidates warranty coverage on parts affected by the lack of maintenance.

Why Maintain Your Vehicle at Your Dealership?

Factory-Trained Technicians

Service technicians participate in extensive factory-sponsored certification training to help them become experts on the operation of your vehicle. Ask your dealership about the training and certification their technicians have received.

Genuine Ford and Motorcraft® Replacement Parts

Dealerships stock Ford, Motorcraft® and Ford-authorized branded remanufactured replacement parts. These parts meet or exceed Ford Motor Company's specifications. Parts installed at your dealership carry a nationwide, 12 month/12000 mile (20000 kilometer) parts and labor limited warranty. If you do not use Ford authorized parts, they may not meet Ford specifications and, depending on the part, it could affect emissions compliance.

Convenience

Many dealerships have extended evening and Saturday hours to make your service visit more convenient and they offer one stop shopping. They can perform any services that are required on your vehicle, from general maintenance to collision repairs.

Note: Not all dealers have extended hours or bodyshops. Please contact your dealer for details.

46

Scheduled Maintenance Guide

Protecting Your Investment

Maintenance is an investment that will pay dividends in the form of improved reliability, durability and resale value. To maintain the proper performance of your vehicle and its emission control systems, it is imperative that scheduled maintenance be completed at the designated intervals.

Your vehicle is very sophisticated and built with multiple, complex, performance systems. Every manufacturer develops these systems using different specifications and performance features. That is why it is important to rely upon your dealership to properly diagnose and repair your vehicle.

Ford Motor Company has recommended maintenance intervals for various parts and component systems based upon engineering testing. Ford Motor Company relies upon this testing to determine the most appropriate mileage for replacement of oils and fluids to protect your vehicle at the lowest overall cost to you and recommends against maintenance schedules that deviate from the scheduled maintenance information.

Ford strongly recommends the use of only genuine Ford, Motorcraft® or Ford-authorized remanufactured replacement parts because they are engineered for your vehicle.

Additives and Chemicals

Ford Motor Company recommended additives and chemicals are listed in the owner manual and in the Ford Workshop Manual. Additional chemicals or additives, not approved by Ford Motor Company, are not recommended as part of normal maintenance. Please consult your warranty information.

Oils, Fluids and Flushing

In many cases, fluid discoloration is a normal operating characteristic and, by itself, does not necessarily indicate a concern or that the fluid needs to be changed. However, discolored fluids that also show signs of overheating and foreign material contamination should be inspected immediately by a qualified expert, such as the factory-trained technicians at your dealership. Your vehicle's oils and fluids should be changed at the specified intervals or in conjunction with a repair. Flushing is a viable way to change fluid for many vehicle sub-systems during scheduled maintenance. It is critical that systems are flushed only with new fluid that is the same as that required to fill and operate the system, or using a Ford-approved flushing chemical.

Scheduled Maintenance Guide

Owner Checks and Services

Certain basic maintenance checks and inspections should be performed every month or at six month intervals.

Check Every Month
Engine oil level.
Function of all interior and exterior lights.
Tires (including spare) for wear and proper pressure.
Windshield washer fluid level.
Check Every Six Months
Battery connections. Clean if necessary.
Body and door drain holes for obstructions. Clean if necessary.
Cooling system fluid level and coolant strength.
Door weatherstrips for wear. Lubricate if necessary.
Hinges, latches and outside locks for proper operation. Lubricate if necessary.
Parking brake for proper operation.
Safety belts and seat latches for wear and function.
Safety warning lamps (brake, ABS, airbag, safety belt) for operation.
Washer spray and wiper operation. Clean or replace blades as necessary.

Scheduled Maintenance Guide

Multi-point Inspection

In order to keep your vehicle running right, it is important to have the systems on your vehicle checked regularly. This can help identify potential issues and prevent major problems. Ford Motor Company recommends the following multi-point inspection be performed at every scheduled maintenance interval to help make sure your vehicle keeps running great.





Multi-point Inspection	
Accessory drive belt(s)	Half-shaft dust boots (if equipped)
Battery performance	Horn operation
Clutch operation (if equipped)	Radiator, cooler, heater and A/C hoses
Engine air filter	Suspension component for leaks or damage
Exhaust system	Steering and linkage
Exterior lamps and hazard warning system operation	Tires (including spare) for wear and proper pressure**
Fluid levels*; fill if necessary	Windshield for cracks, chips or pits
For oil and fluid leaks	Washer spray and wiper operation

*Brake, coolant recovery reservoir, manual and automatic transmission (with an underhood dipstick), power steering (if equipped) and window washer

**If your vehicle is equipped with a temporary mobility kit, check the tire sealant expiration Use By date on the canister. Replace as needed.

Be sure to ask your dealership service advisor or technician about the multi-point vehicle inspection. It's a comprehensive way to perform a thorough inspection of your vehicle. It's your checklist that gives you immediate feedback on the overall condition of your vehicle. You'll know what's been checked, what's okay, as well as those things that may require future or immediate attention. The multi-point vehicle inspection is one more way to keep your vehicle running great!

Scheduled Maintenance Guide

 LINKEDIN   **GENUINE FORD PARTS & SERVICE**  Panel's Member #: _____ Panel's Service Balance: _____

Multi-Point Inspection Report Card as Recommended by Ford Motor Company

Name: _____ Date: _____ Mileage: _____ Static Inspection Month: _____

E-Mail Address: _____

SCHEDULED MAINTENANCE ITEMS DUE FOR SERVICES ON THIS VEHICLE

ITEM	STATUS	ITEM	STATUS
Cabin Air Filter	<input type="checkbox"/>	Oil Filter	<input type="checkbox"/>
Engine Air Filter	<input type="checkbox"/>	Spark Plugs	<input type="checkbox"/>
Engine Coolant	<input type="checkbox"/>	Tire Rotation	<input type="checkbox"/>
Wax Filter	<input type="checkbox"/>	Transmission Fluid	<input type="checkbox"/>
Oil Change	<input type="checkbox"/>		

**This is only a partial list of vehicle maintenance items and is NOT all-inclusive. Please consult your Owner's Manual or visit www.ford.com for vehicle specific maintenance requirements.*

CHECK FLUID LEVELS AND FILL

Oil and/or fluid leaks	<input type="checkbox"/>
Wash Fluid	<input type="checkbox"/>
Power Steering	<input type="checkbox"/>
Washer Fluid	<input type="checkbox"/>
Battery	<input type="checkbox"/>
Brake Fluid	<input type="checkbox"/>
Coolant	<input type="checkbox"/>

BATTERY

State of Health: _____ Condition of _____

Factory spec cold cranking amps: _____

EXTERIOR BODY

Note any existing exterior body damage or defects:



SYNCHRONIZED VEHICLE HEALTH CHECK (EVERY 10000 MILES)

Check and top off tires	<input type="checkbox"/>
Check and top off fluids	<input type="checkbox"/>
Check and top off belts and hoses	<input type="checkbox"/>
Check and top off brakes	<input type="checkbox"/>

CHECK FOLLOWING SYSTEMS

Brake system (braking lines, hoses, including brake)	<input type="checkbox"/>
Exhaust system (leaks, damage, loose parts)	<input type="checkbox"/>
Transmission and drive axle (leaks, damage, loose parts)	<input type="checkbox"/>
Steering system (tie rods, ball joints)	<input type="checkbox"/>
Exhaust system (leaks, damage, loose parts)	<input type="checkbox"/>
Transmission and drive axle (leaks, damage, loose parts)	<input type="checkbox"/>
Steering system (tie rods, ball joints)	<input type="checkbox"/>

EXHAUST SYSTEM

Exhaust system (leaks, damage, loose parts)

TRANSMISSION AND DRIVE AXLE

Transmission and drive axle (leaks, damage, loose parts)

STEERING SYSTEM

Steering system (tie rods, ball joints)

LIGHTS/BLADES/WINDSHIELD

Operation of front, rear, brake, turn, hazard, fog, and backup lights

Windshield wiper blades, wiper operation and wiper blades

Windshield for cracks, chips and pitting

BELTS AND HOSES/MOUNTS

HWAC system and hoses/leaks and/or damage

Engine Cooling system, radiator, hoses and clamps

Accessory drive belts

TIRES/ BRAKE WEAR

TIRES

Front Left	Tire Tread Depth	_____ /32"	Wear Pattern	<input type="checkbox"/>
Front Right	Tire Tread Depth	_____ /32"	Wear Pattern	<input type="checkbox"/>
Rear Left	Tire Tread Depth	_____ /32"	Wear Pattern	<input type="checkbox"/>
Rear Right	Tire Tread Depth	_____ /32"	Wear Pattern	<input type="checkbox"/>

TIRES WEAR INDICATES:

Alignment check needed	<input type="checkbox"/>
Tire repair needed	<input type="checkbox"/>
Tire repair needed (not taken into service list)	<input type="checkbox"/>

Comments: _____

Service Advisor: _____ Customer Signature: _____

Technician: _____ Customer Copy

12-XXXXXXX

Scheduled Maintenance Guide

NORMAL SCHEDULED MAINTENANCE AND LOG

The following section contains the Normal Schedule. This schedule is presented at specific mileage (kilometer) intervals with exceptions noted.

Normal Scheduled Maintenance	
Every 7500 miles (12000 km) or six months (whichever comes first)	Change engine oil and filter.
	Inspect cabin air filter (if equipped).
	Inspect tire wear and measure tread depth.*
	Inspect wheels and related components for abnormal noise, wear, looseness or drag.
	Perform multi-point inspection (recommended).
Every 15000 miles (24000 km) or 12 months (whichever comes first)	Inspect brake pads, shoes, rotors, drums, brake linings, hoses and parking brake.
	Inspect engine cooling system strength and hoses.
	Inspect exhaust system and heat shields.
	Inspect steering linkage, ball joints, suspension, tie-rod ends, driveshaft and U-joints. Lubricate if equipped with grease fittings.

*Refer to the *Wheels and Tires* chapter for tire rotation information.

Scheduled Maintenance Guide

Additional Maintenance Items	
Every 15000 miles (24000 km)	Replace cabin air filter (if equipped).
Every 30000 miles (48000 km)	Replace engine air filter.
	Replace fuel filter.
Every 45000 miles (72000 km)	Replace spark plugs.
Every 105000 miles (168000 km)	Change engine coolant.*
	Inspect accessory drive belt(s).**
Every 150000 miles (240000 km)	Change manual transmission fluid.
	Change rear axle fluid.
	Replace accessory drive belt(s) if not replaced within the last 100000 miles (160000 km).

*Initial replacement at six years or 105000 miles (168000 kilometers), then every three years or 45000 miles (72000 kilometers).

**If not replaced, inspect every 15000 miles (24000 kilometers).

Scheduled Maintenance Guide

Maintenance Schedule Log

<p style="text-align: center;">DEALER VALIDATION:</p> <p style="text-align: center;">P&A CODE:</p> <p>RO#: HOURS:</p> <p>DATE: MILEAGE:</p>	<p style="text-align: center;">DEALER VALIDATION:</p> <p style="text-align: center;">P&A CODE:</p> <p>RO#: HOURS:</p> <p>DATE: MILEAGE:</p>
<p style="text-align: center;">DEALER VALIDATION:</p> <p style="text-align: center;">P&A CODE:</p> <p>RO#: HOURS:</p> <p>DATE: MILEAGE:</p>	<p style="text-align: center;">DEALER VALIDATION:</p> <p style="text-align: center;">P&A CODE:</p> <p>RO#: HOURS:</p> <p>DATE: MILEAGE:</p>
<p style="text-align: center;">DEALER VALIDATION:</p> <p style="text-align: center;">P&A CODE:</p> <p>RO#: HOURS:</p> <p>DATE: MILEAGE:</p>	<p style="text-align: center;">DEALER VALIDATION:</p> <p style="text-align: center;">P&A CODE:</p> <p>RO#: HOURS:</p> <p>DATE: MILEAGE:</p>
<p style="text-align: center;">DEALER VALIDATION:</p> <p style="text-align: center;">P&A CODE:</p> <p>RO#: HOURS:</p> <p>DATE: MILEAGE:</p>	<p style="text-align: center;">DEALER VALIDATION:</p> <p style="text-align: center;">P&A CODE:</p> <p>RO#: HOURS:</p> <p>DATE: MILEAGE:</p>
<p style="text-align: center;">DEALER VALIDATION:</p> <p style="text-align: center;">P&A CODE:</p> <p>RO#: HOURS:</p> <p>DATE: MILEAGE:</p>	<p style="text-align: center;">DEALER VALIDATION:</p> <p style="text-align: center;">P&A CODE:</p> <p>RO#: HOURS:</p> <p>DATE: MILEAGE:</p>

Scheduled Maintenance Guide

<p style="text-align: center;">DEALER VALIDATION:</p> <p style="text-align: center;">P&A CODE:</p> <p>RO#: HOURS:</p> <p>DATE: MILEAGE:</p>	<p style="text-align: center;">DEALER VALIDATION:</p> <p style="text-align: center;">P&A CODE:</p> <p>RO#: HOURS:</p> <p>DATE: MILEAGE:</p>
<p style="text-align: center;">DEALER VALIDATION:</p> <p style="text-align: center;">P&A CODE:</p> <p>RO#: HOURS:</p> <p>DATE: MILEAGE:</p>	<p style="text-align: center;">DEALER VALIDATION:</p> <p style="text-align: center;">P&A CODE:</p> <p>RO#: HOURS:</p> <p>DATE: MILEAGE:</p>
<p style="text-align: center;">DEALER VALIDATION:</p> <p style="text-align: center;">P&A CODE:</p> <p>RO#: HOURS:</p> <p>DATE: MILEAGE:</p>	<p style="text-align: center;">DEALER VALIDATION:</p> <p style="text-align: center;">P&A CODE:</p> <p>RO#: HOURS:</p> <p>DATE: MILEAGE:</p>
<p style="text-align: center;">DEALER VALIDATION:</p> <p style="text-align: center;">P&A CODE:</p> <p>RO#: HOURS:</p> <p>DATE: MILEAGE:</p>	<p style="text-align: center;">DEALER VALIDATION:</p> <p style="text-align: center;">P&A CODE:</p> <p>RO#: HOURS:</p> <p>DATE: MILEAGE:</p>
<p style="text-align: center;">DEALER VALIDATION:</p> <p style="text-align: center;">P&A CODE:</p> <p>RO#: HOURS:</p> <p>DATE: MILEAGE:</p>	<p style="text-align: center;">DEALER VALIDATION:</p> <p style="text-align: center;">P&A CODE:</p> <p>RO#: HOURS:</p> <p>DATE: MILEAGE:</p>

Scheduled Maintenance Guide

<p style="text-align: center;">DEALER VALIDATION:</p> <p style="text-align: center;">P&A CODE:</p> <p>RO#: HOURS:</p> <p>DATE: MILEAGE:</p>	<p style="text-align: center;">DEALER VALIDATION:</p> <p style="text-align: center;">P&A CODE:</p> <p>RO#: HOURS:</p> <p>DATE: MILEAGE:</p>
<p style="text-align: center;">DEALER VALIDATION:</p> <p style="text-align: center;">P&A CODE:</p> <p>RO#: HOURS:</p> <p>DATE: MILEAGE:</p>	<p style="text-align: center;">DEALER VALIDATION:</p> <p style="text-align: center;">P&A CODE:</p> <p>RO#: HOURS:</p> <p>DATE: MILEAGE:</p>
<p style="text-align: center;">DEALER VALIDATION:</p> <p style="text-align: center;">P&A CODE:</p> <p>RO#: HOURS:</p> <p>DATE: MILEAGE:</p>	<p style="text-align: center;">DEALER VALIDATION:</p> <p style="text-align: center;">P&A CODE:</p> <p>RO#: HOURS:</p> <p>DATE: MILEAGE:</p>
<p style="text-align: center;">DEALER VALIDATION:</p> <p style="text-align: center;">P&A CODE:</p> <p>RO#: HOURS:</p> <p>DATE: MILEAGE:</p>	<p style="text-align: center;">DEALER VALIDATION:</p> <p style="text-align: center;">P&A CODE:</p> <p>RO#: HOURS:</p> <p>DATE: MILEAGE:</p>
<p style="text-align: center;">DEALER VALIDATION:</p> <p style="text-align: center;">P&A CODE:</p> <p>RO#: HOURS:</p> <p>DATE: MILEAGE:</p>	<p style="text-align: center;">DEALER VALIDATION:</p> <p style="text-align: center;">P&A CODE:</p> <p>RO#: HOURS:</p> <p>DATE: MILEAGE:</p>

Scheduled Maintenance Guide

SPECIAL OPERATING CONDITIONS

If you operate your vehicle **primarily** in any of the following conditions, you need to perform additional maintenance as indicated. If you **occasionally** operate your vehicle under any of these conditions, it is not necessary to perform the additional maintenance. For specific recommendations, see your dealership service advisor or technician.

Extensive Idling or Low-speed Driving for Long Distances as in Heavy Commercial Use (i.e., Delivery, Taxi, Patrol Car or Livery)	
Inspect frequently, service as required	Replace cabin air filter (if equipped).
	Replace engine air filter.
Every 5000 miles (8000 km)	Inspect brake system.
	Inspect tires for wear and measure tread depth.
	Inspect the wheels and related components for abnormal noise, wear, looseness or drag.
	Lubricate control arm and steering ball joints (if equipped with grease fittings).
Every 5000 miles (8000 km) or six months	Inspect CV joint boots for loose clamps, damage or grease leakage.
Every 5000 miles (8000 km), six months or 200 hours of engine operation	Change engine oil and filter.

Scheduled Maintenance Guide

Operating in Dusty or Sandy Conditions Such as Unpaved or Dusty Roads	
Inspect frequently, service as required	Replace cabin air filter (if equipped).
	Replace engine air filter.
Every 5000 miles (8000 km)	Inspect tires for wear and measure tread depth.
	Inspect the wheels and related components for abnormal noise, wear, looseness or drag.
Every 5000 miles (8000 km) or six months	Change engine oil and filter.
	Inspect CV joint boots for loose clamps, damage or grease leakage.
Every 50000 miles (80000 km)	Change manual transmission fluid.

Scheduled Maintenance Guide

Special Operating Condition Log

<p style="text-align: center;">DEALER VALIDATION:</p> <p style="text-align: center;">P&A CODE:</p> <p>RO#: HOURS:</p> <p>DATE: MILEAGE:</p>	<p style="text-align: center;">DEALER VALIDATION:</p> <p style="text-align: center;">P&A CODE:</p> <p>RO#: HOURS:</p> <p>DATE: MILEAGE:</p>
<p style="text-align: center;">DEALER VALIDATION:</p> <p style="text-align: center;">P&A CODE:</p> <p>RO#: HOURS:</p> <p>DATE: MILEAGE:</p>	<p style="text-align: center;">DEALER VALIDATION:</p> <p style="text-align: center;">P&A CODE:</p> <p>RO#: HOURS:</p> <p>DATE: MILEAGE:</p>
<p style="text-align: center;">DEALER VALIDATION:</p> <p style="text-align: center;">P&A CODE:</p> <p>RO#: HOURS:</p> <p>DATE: MILEAGE:</p>	<p style="text-align: center;">DEALER VALIDATION:</p> <p style="text-align: center;">P&A CODE:</p> <p>RO#: HOURS:</p> <p>DATE: MILEAGE:</p>
<p style="text-align: center;">DEALER VALIDATION:</p> <p style="text-align: center;">P&A CODE:</p> <p>RO#: HOURS:</p> <p>DATE: MILEAGE:</p>	<p style="text-align: center;">DEALER VALIDATION:</p> <p style="text-align: center;">P&A CODE:</p> <p>RO#: HOURS:</p> <p>DATE: MILEAGE:</p>
<p style="text-align: center;">DEALER VALIDATION:</p> <p style="text-align: center;">P&A CODE:</p> <p>RO#: HOURS:</p> <p>DATE: MILEAGE:</p>	<p style="text-align: center;">DEALER VALIDATION:</p> <p style="text-align: center;">P&A CODE:</p> <p>RO#: HOURS:</p> <p>DATE: MILEAGE:</p>

Scheduled Maintenance Guide

<p style="text-align: center;">DEALER VALIDATION:</p> <p style="text-align: center;">P&A CODE:</p> <p>RO#: HOURS:</p> <p>DATE: MILEAGE:</p>	<p style="text-align: center;">DEALER VALIDATION:</p> <p style="text-align: center;">P&A CODE:</p> <p>RO#: HOURS:</p> <p>DATE: MILEAGE:</p>
<p style="text-align: center;">DEALER VALIDATION:</p> <p style="text-align: center;">P&A CODE:</p> <p>RO#: HOURS:</p> <p>DATE: MILEAGE:</p>	<p style="text-align: center;">DEALER VALIDATION:</p> <p style="text-align: center;">P&A CODE:</p> <p>RO#: HOURS:</p> <p>DATE: MILEAGE:</p>
<p style="text-align: center;">DEALER VALIDATION:</p> <p style="text-align: center;">P&A CODE:</p> <p>RO#: HOURS:</p> <p>DATE: MILEAGE:</p>	<p style="text-align: center;">DEALER VALIDATION:</p> <p style="text-align: center;">P&A CODE:</p> <p>RO#: HOURS:</p> <p>DATE: MILEAGE:</p>
<p style="text-align: center;">DEALER VALIDATION:</p> <p style="text-align: center;">P&A CODE:</p> <p>RO#: HOURS:</p> <p>DATE: MILEAGE:</p>	<p style="text-align: center;">DEALER VALIDATION:</p> <p style="text-align: center;">P&A CODE:</p> <p>RO#: HOURS:</p> <p>DATE: MILEAGE:</p>
<p style="text-align: center;">DEALER VALIDATION:</p> <p style="text-align: center;">P&A CODE:</p> <p>RO#: HOURS:</p> <p>DATE: MILEAGE:</p>	<p style="text-align: center;">DEALER VALIDATION:</p> <p style="text-align: center;">P&A CODE:</p> <p>RO#: HOURS:</p> <p>DATE: MILEAGE:</p>

Scheduled Maintenance Guide

EXCEPTIONS

There are several exceptions to the Normal Schedule. They are listed below:

Normal vehicle axle maintenance: Rear axles and power take-off (PTO) units with synthetic fluid and light-duty trucks equipped with Ford-design axles are lubricated for life; do not check or change fluid unless a leak is suspected, service is required or the assembly has been submerged in water. During long periods of trailer towing with outside temperatures above 70°F (21°C) and at wide-open throttle for long periods above 45 mph (72 km/h), non-synthetic rear axle fluids should be changed every 3000 miles (4800 kilometers) or three months, whichever comes first. This interval can be waived if the axle is filled with 75W85 Premium Synthetic Hypoid Gear Lubricant meeting Ford specification WSS-M2C942-A, part number XY-75W85-QL or equivalent. Add friction modifier XL-3 (EST-M2C118-A) or equivalent for complete refill of Traction-Lok rear axles (refer to the *Capacities and Specifications* chapter for details).

Police/Taxi/Livery vehicle axle maintenance: Change rear axle fluid every 100000 miles (160000 km). Rear axle fluid change may be waived if the axle was filled with 75W140 synthetic gear fluid meeting Ford specification WSL-M2C192-A, part number FITZ-19580-B or equivalent. Add four ounces (118 mL) of additive friction modifier XL-3 (EST-M2C118-A) or equivalent for complete refill of Traction-Lok rear axles. The axle fluid should be changed anytime the axle has been submerged in water.

California fuel filter replacement: If the vehicle is registered in California, the California Air Resources Board has determined that the failure to perform this maintenance item will not nullify the emission warranty or limit recall liability prior to the completion of the vehicle's useful life. Ford Motor Company, however, urges you to have all recommended maintenance services performed at the specified intervals and to record all vehicle service.

Hot climate oil change intervals: Vehicles operating in the Middle East, North Africa, Sub-Saharan Africa or locations with similar climates using an American Petroleum Institute (API) Certified for Gasoline Engines (Certification mark) oil of SM or SN quality, the normal oil change interval is 5000 miles (8000 kilometers). If the available API SM or SN oils are not available, then the oil change service interval is 3000 miles (4800 kilometers).

Engine air filter replacement: Engine air filter life is dependent on exposure to dusty and dirty conditions. Vehicles operated in these conditions require frequent inspection and replacement of the engine air filter.

60

Scheduled Maintenance Guide

ENGINE COOLANT CHANGE RECORD

Initial change	Six years or 105000 miles (168000 km) (whichever comes first)
After initial change	Every three years or 45000 miles (72000 km)

Engine Coolant Change Log

<p style="text-align: center;">DEALER VALIDATION:</p> <p>RO#: P&A CODE: HOURS: DATE: MILEAGE:</p>	<p style="text-align: center;">DEALER VALIDATION:</p> <p>RO#: P&A CODE: HOURS: DATE: MILEAGE:</p>
<p style="text-align: center;">DEALER VALIDATION:</p> <p>RO#: P&A CODE: HOURS: DATE: MILEAGE:</p>	<p style="text-align: center;">DEALER VALIDATION:</p> <p>RO#: P&A CODE: HOURS: DATE: MILEAGE:</p>
<p style="text-align: center;">DEALER VALIDATION:</p> <p>RO#: P&A CODE: HOURS: DATE: MILEAGE:</p>	<p style="text-align: center;">DEALER VALIDATION:</p> <p>RO#: P&A CODE: HOURS: DATE: MILEAGE:</p>

Index

- A**
- AdvanceTrac16
 - Air cleaner filter40–41
 - Axle
 - refill capacities42
- B**
- Battery
 - replacement, specifications41
 - Brakes
 - fluid, refill capacities42
 - Break-in period11
- C**
- Capacities for refilling fluids42
 - Clutch
 - recommended shift speeds13
 - Coolant
 - refill capacities42
- E**
- Electric power assisted steering22
 - Electronically selectable dampers21
 - Engine8
 - refill capacities42
 - service points34
 - Engine oil
 - filter, specifications41
 - refill capacities42
- F**
- Fluid capacities42
- 62
- Fuel
 - capacity42
 - filter, specifications41
 - octane rating8, 39
- H**
- Headlamps
 - bulb specifications44
- I**
- Ignition8
 - Instrument panel
 - cluster14
- L**
- Lamps
 - bulb replacement specifications chart44
 - Launch control20
 - Lights, warning and indicator14
 - Lug nuts25
- M**
- Manual transmission
 - fluid capacities42
 - Motorcraft® parts41
- O**
- Octane rating39
- P**
- Parts (see Motorcraft® parts) ..41

Index

- S**
- Scheduled Maintenance Guide
 - Normal Scheduled Maintenance and Log51
 - Spark plugs, specifications8, 41
- T**
- Tires
 - changing26
- W**
- Towing
 - wrecker29
 - Transmission
 - fluid, refill capacities42
 - Warning lights (see Lights)14
 - Wrecker towing29